

ACCESSORIES

Cardiac Rhythm Management

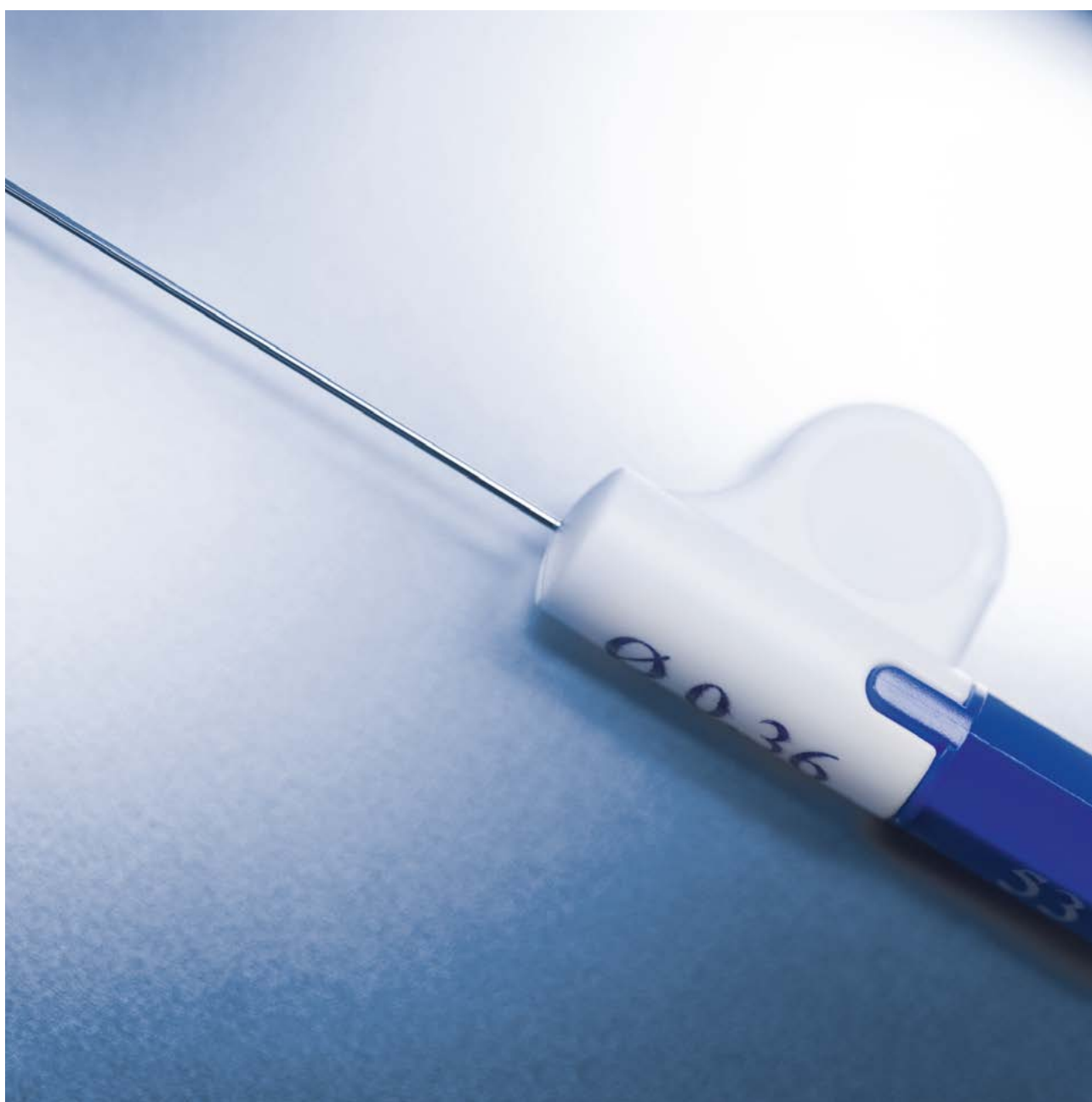

BIOTRONIK
excellence for life

IMPORTANT NOTE:

- For country specific availability of OEM products please contact your local sales representative.
- All products in this overview are subject to local regulatory approval, if applicable.

Content

1 About BIOTRONIK

1

Accessories for

2 Leads, Pacemakers and ICDs (single- and dual-chamber)

2

Adapter
Lead Introducer System
Stylets
Lead Fixation Sleeves
Fixation Tool
Vein Lifter
Screwdriver
Medical Silicone Oil
Magnet
Blind Caps
Blind Plugs

3 CRT-P and CRT-D (triple-chamber)

3

Telescopic Coronary Sinus Lead Delivery System (Selectra)
LV Coronary Sinus Lead Delivery System CSG
Lead Introducer System with Valve (SafeSheath II)
Balloon Catheter (Corodyn)
Guide Wires (Streamer and VisionWire)

4 Arrhythmia Monitoring

4

BioMonitor 2 (Cardiac Monitor)

5 BIOTRONIK Home Monitoring®

5

6 External Devices

6

Programmer and Monitoring Device (Renamic)
Expansion Modul for Renamic (PSA Modul)
Patient Cables
Patient Adapter
Further Accessories

About BIOTRONIK

From Vision to Impact.
That's Excellence for Life.



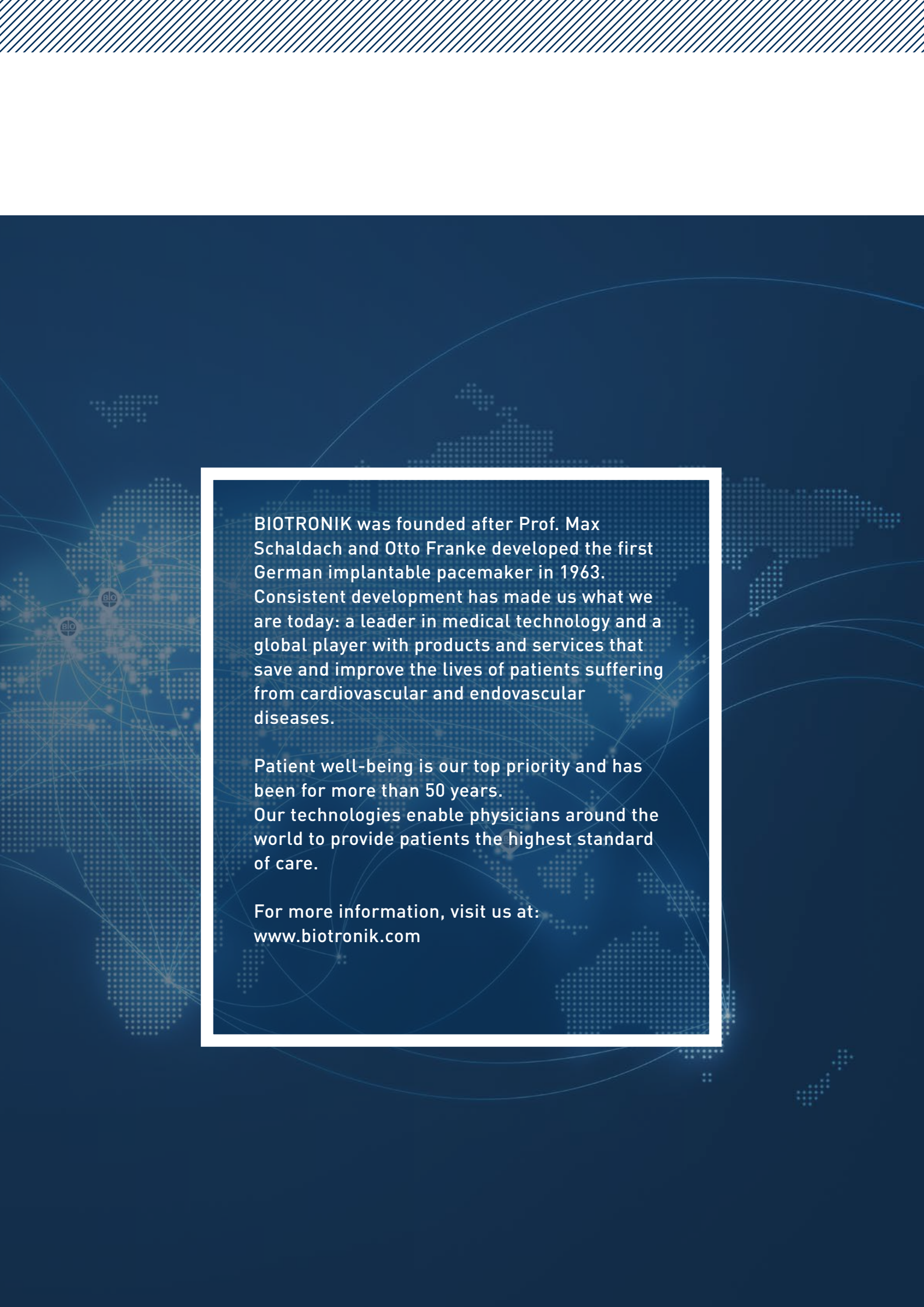

BIOTRONIK was founded after Prof. Max Schaldach and Otto Franke developed the first German implantable pacemaker in 1963. Consistent development has made us what we are today: a leader in medical technology and a global player with products and services that save and improve the lives of patients suffering from cardiovascular and endovascular diseases.

Patient well-being is our top priority and has been for more than 50 years.

Our technologies enable physicians around the world to provide patients the highest standard of care.

For more information, visit us at:
www.biotronik.com

2 Leads, Pacemakers and ICDs (single- and dual-chamber)

Adapter



Model	Order Number	Packaging Unit	Length	Description
A1-N	114 316	1 pc.	11 cm	Adapter for unipolar leads without connectors to an IS-1 connection

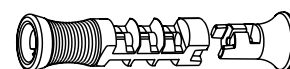

Model	Order Number	Packaging Unit	Length	Description
IS4/DF4	412 302	5 pcs.	4,3 cm	Measurement adapter to connect a lead with an IS4/DF4 connector to alligator clips
	412 303	1 pc.		

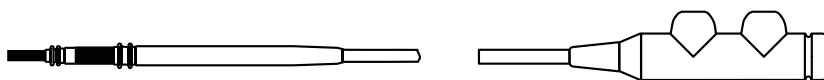

Model	Order Number	Packaging Unit	Length	Description
VB10-IS-LVB ¹	370 606	1 pc.	10 cm	Adapter to connect bipolar LV-1 leads (Guidant) to an IS-1 bipolar connector block

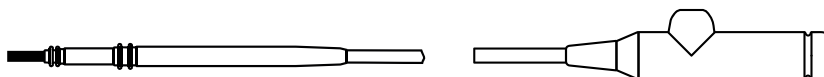

Model	Order Number	Packaging Unit	Length	Description
VU10-IS-LV ¹	370 607	1 pc.	10 cm	Adapter to connect unipolar LV-1 leads (Guidant) to an IS-1 unipolar connector block

¹ Manufacturer: OSYPKA AG, Earl-H. Wood-Str. 1, 79618 Rheinfelden, Germany

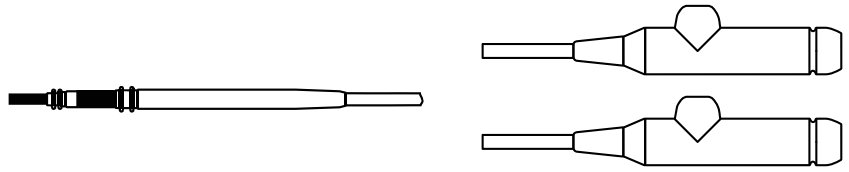

Model	Order Number	Packaging Unit	Length	Description
VIS 16 ¹	400 276	1 pc.	15 cm	Adapter to connect 2x IS-1 unipolar to IS-1 bipolar

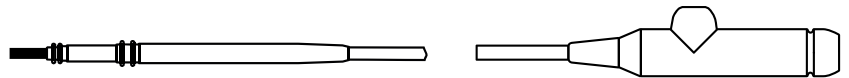

Model	Order Number	Packaging Unit	Length	Description
VM17 ¹	391 854	1 pc.	10 cm	Adapter to connect 5 mm leads (Medtronic) to an IS-1 unipolar connector block

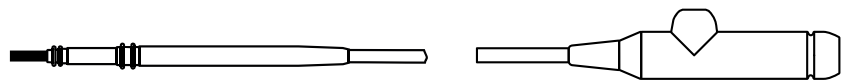

Model	Order Number	Packaging Unit	Length	Description
VC17 ¹	391 853	1 pc.	10 cm	Adapter to connect 6 mm leads (Cordis) to an IS-1 unipolar connector block

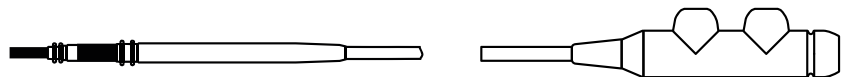

Model	Order Number	Packaging Unit	Length	Description
VB17-IS-ISB ¹	391 851	1 pc.	17 cm	Lead Extension, IS-1 to IS-1 connector, bipolar
VB40-IS-ISB ¹	391 855	1 pc.	40 cm	

¹ Manufacturer: OSYPKA AG, Earl-H. Wood-Str. 1, 79618 Rheinfelden, Germany

2 Leads, Pacemakers and ICDs (single- and dual-chamber)

Lead Introducer System

Lead introducer system for implantation of all standard leads

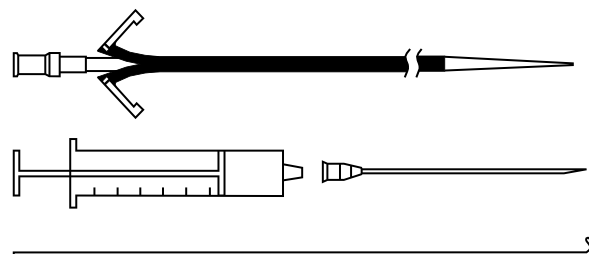

Model	Order Number	Packaging Unit	Size (Inner Diameter)	Length
LI-6 ^{plus} G ²	367 568	5 pcs.	6 F	15 cm
LI-7 ^{plus} G ²	367 569	5 pcs.	7 F	15 cm
LI-8 ^{plus} G ²	367 570	5 pcs.	8 F	15 cm
LI-9 ^{plus} G ²	367 571	5 pcs.	9 F	15 cm
LI-10 ^{plus} G ²	367 572	5 pcs.	10 F	15 cm
LI-11 ^{plus} G ²	367 573	5 pcs.	11 F	15 cm
LI-12 ^{plus} G ²	367 574	5 pcs.	12 F	15 cm

Model	Order Number	Packaging Unit	Size (Inner Diameter)	Length
LI-6 ^{plus} GB ³	417 669	5 pcs.	6 F	15 cm
LI-7 ^{plus} GB ³	417 670	5 pcs.	7 F	15 cm
LI-8 ^{plus} GB ³	417 671	5 pcs.	8 F	15 cm
LI-9 ^{plus} GB ³	417 672	5 pcs.	9 F	15 cm
LI-10 ^{plus} GB ³	417 673	5 pcs.	10 F	15 cm
LI-11 ^{plus} GB ³	417 674	5 pcs.	11 F	15 cm
LI-12 ^{plus} GB ³	417 675	5 pcs.	12 F	15 cm

² Manufacturer: GALT Medical Corp., 2220 Merrit Drive, Garland, TX 75041, USA

³ Manufacturer: Greatbatch Medical, 2300 Berkshire Lane North, Minneapolis, MN 55441, USA

2 Leads, Pacemakers and ICDs (single- and dual-chamber)

Stylets

Stylets predominantly serve to stiffen the flexible lead during the implantation in order to facilitate its positioning.



For Pacemaker Leads

Model	Order Number		Length	Stiffness	Shape	Color coding, handle	
	10 pcs.	1 pc.				Proximal	Distal
S 45-F	130 091	395 085	45 cm	soft	straight	black	red
S 45-J	113 395	395 086	45 cm	medium	J-shaped	black	grey
S 45-JL	353 385	395 087	45 cm	medium	JL-shaped	black	black
S 45-K	113 588	395 088	45 cm	medium	straight	black	white
S 45-S	130 011	395 089	45 cm	stiff	straight	black	orange
S 53-F	130 093	395 090	53 cm	soft	straight	blue	red
S 53-J	107 237	395 091	53 cm	medium	J-shaped	blue	grey
S 53-JL	353 234	395 092	53 cm	medium	JL-shaped	blue	black
S 53-K	107 235	395 093	53 cm	medium	straight	blue	white
S 53-S	130 013	395 094	53 cm	stiff	straight	blue	orange
S 58-K	118 877	395 095	58 cm	medium	straight	red	white
S 60-F	124 697	395 102	60 cm	soft	straight	green	red
S 60-J	106 164	395 103	60 cm	medium	J-shaped	green	grey
S 60-K	106 162	395 104	60 cm	medium	straight	green	white
S 60-S	119 291	395 105	60 cm	stiff	straight	green	orange

For ICD Leads

Model	Order Number			Length	Stiffness & Shape	Color coding, handle	
	10 pcs.	2 pcs.	1 pc.			Proximal	Distal
S 60-C	359 223		395 096	60 cm	medium / straight	green	yellow
S 60-K	106 162		395 104	60 cm	soft / straight	green	white
S 65-A	333 413		395 097	65 cm	stiff / straight	yellow	green
S 65-C	342 657		395 098	65 cm	medium / straight	yellow	yellow
S 65-E		344 044		65 cm	extra stiff / straight	dark green	dark green
S 65-K	117 464		395 099	65 cm	soft / straight	yellow	white
S 75-A	124 208		395 100	75 cm	stiff / straight	white	green
S 75-C	124 301		395 101	75 cm	medium / straight	white	yellow
S 75-E		124 437		75 cm	extra stiff / straight	golden yellow	golden yellow
S 75-K	121 197		395 106	75 cm	soft / straight	white	white

For LV Leads (CRT)

Model	Order Number		Length	Stiffness & Shape	Color coding, handle
	10 pcs.	1 pc.			
S 75-G OTW	346 977	395 107	75 cm	soft / straight	purple
S 75-K OTW	346 978	395 108	75 cm	medium / straight	green
S 85-G OTW	346 979	395 109	85 cm	soft / straight	purple
S 85-K OTW	346 980	395 110	85 cm	medium / straight	green
S 95-G OTW	375 093	395 400	95 cm	soft / straight	purple
S 95-K OTW	375 094	395 401	95 cm	medium / straight	green

2 Leads, Pacemakers and ICDs (single- and dual-chamber)

Lead Fixation Sleeves

Lead Fixation Sleeves are intended for the fixation of chronically implanted leads.

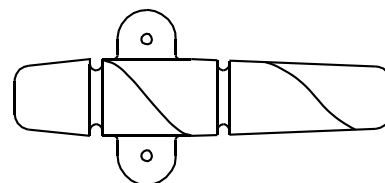

Model	Order Number		For Leads with an Outer Diameter of	Type
	10 pcs.	1 pc.		
EFH-16	115 489	395 112	1.6 mm (4.8 F)	slitted, colorless
EFH-20	106 158	395 113	1.8 mm (5.4 F)	slitted, colorless
EFH-22	330 489	395 114	2.0 mm (6 F)	slitted, colorless
EFH-25	107 622	395 115	2.3 mm (6.9 F)	slitted, colorless
EFH-27	331 549	395 116	2.4 mm (7 F)	slitted, colorless
EFH-28	109 181	395 117	2.5 mm (7.5 F)	slitted, colorless
EFH-30	119 964	395 118	2.6 mm (7.8 F)	slitted, colorless
EFH-35	342 381	395 119	3.2 mm (9.6 F)	slitted, colorless
EFH-35C	347 400	395 120	3.2 mm (9.6 F)	slitted, colorless



Model	Order Number		For Leads with an Outer Diameter of	Type
	5 pcs.	1 pc.		
EFH-6F-W*	433 306	433 307	2.0 mm (6 F)	not slitted, white
EFH-7F-W	401 012	401 013	2.4 mm (7 F)	not slitted, white
EFH-8F-W	401 014	401 015	2.7 mm (8 F)	not slitted, white

Fixation Tool

The fixation tool is used to retract or extend the fixation screw of active fixation leads (for IS-1 and DF4 connector).

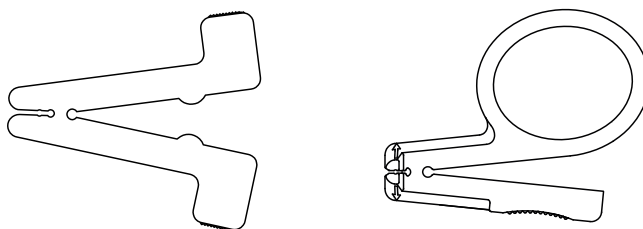

Model	Order Number		Lead Connector
	5 pcs.	1 pc.	
DH	331 668	395 111	IS-1
DH DF4	379 137	395 402	DF4
DH IS-1/DF4	401 298	401 297	IS-1/DF4

* Expected availability from the first quarter of 2019

Vein Lifter

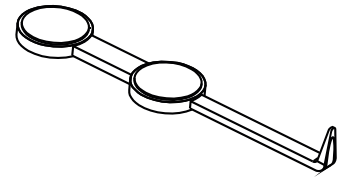

Model	Order Number		Description
	5 pcs.	1 pc.	
VL	106 157	395 084	The VL vein lifter is used to facilitate the intravenous implantation of leads for pacemakers or ICDs.

Screwdriver



Model	Order Number		Description
	5 pcs.	1 pc.	
TW	108 984	395 121	The screwdriver with torque control is used to connect leads or accessories to the IS-1, DF-1, IS4 or DF4 connectors compatible with the corresponding lead connector for pacemaker or ICD.

Medical Silicone Oil

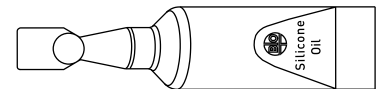

Model	Order Number	Packaging Unit	Description
SI-2	106 119	5 pcs.	The medical silicone oil is used to lubricate stylets in order to ease introduction into the lead.

Magnet

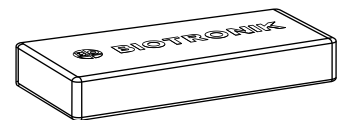

Model	Order Number	Packaging Unit	Description
M-50	112 149	1 pc.	Magnet for pacemaker function test Permanent magnet, non-sterile, dimensions: (WxHxD): 60 x 17 x 26 mm Mass: 0,185 kg, magnetic flux density: at least 12,5 mT

2 Leads, Pacemakers and ICDs (single- and dual-chamber)

Blind Caps

The blind caps are used to safely insulate implanted leads (with or without lead connectors) that remain unused in the patient's body.

Model	Order Number		Lead Connector
	10 pcs.	1 pc.	
BK-IS	109 185	395 079	IS-1

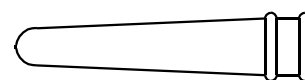

Model	Order Number		Lead Connector
	10 pcs.	1 pc.	
BK-IS4/DF4	378 456	395 399	IS4/DF4

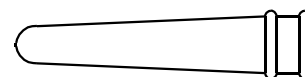

Model	Order Number		Lead Connector
	10 pcs.	1 pc.	
BK-N	109 224	395 080	Without lead connector and an outer diameter between 1.2 and 2.4 mm / for leads between 4 and 7 F

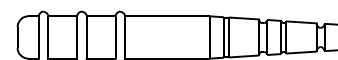

Model	Order Number	Packaging Unit	Lead Connector
Silicone End Cap 5 mm ¹	404 998	1 pc.	5 mm, unipolar
Silicone End Cap 6 mm ¹	404 999	1 pc.	6 mm, unipolar

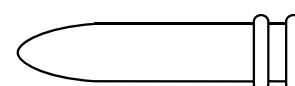

¹Manufacturer: OSYPKA AG, Earl-H. Wood-Str. 1, 79618 Rheinfeldern, Germany

Blind Plugs

The blind plugs securely close and seal unused DF-1, IS-1 or IS4 connector ports in the header of active devices.



Model	Order Number		Device Connector	Device
	10 pcs.	1 pc.		
BS DF-1	119 602	395 082	DF-1	ICD

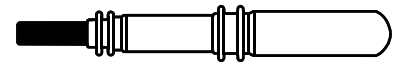

Model	Order Number		Device Connector	Device
	10 pcs.	1 pc.		
BS IS-1	330 834	395 081	IS-1	Pacemaker



Model	Order Number		Device Connector	Device
	5 pcs.	1 pc.		
BS IS4	403 724	403 725	IS4	ICD and Pacemaker

3 CRT-P and CRT-D (triple-chamber)

Telescopic Coronary Sinus Lead Delivery System Selectra

Peel-away introducer sheath with valve to introduce coronary sinus lead delivery system

Outer Catheters

Model	Order Number	Packaging Unit	Inner Diameter	Length	Curve Shapes
Selectra Amplatz 6.0-45	375 519	1 pc.	7,3 F	45 cm	Amplatz 6.0
Selectra Amplatz 6.0-55	375 520	1 pc.	7,3 F	55 cm	Amplatz 6.0
Selectra BIO2-45	375 523	1 pc.	7,3 F	45 cm	BIO2
Selectra BIO2-55	375 524	1 pc.	7,3 F	55 cm	BIO2
Selectra Extended Hook-45	375 527	1 pc.	7,3 F	45 cm	Extended Hook
Selectra Extended Hook-55	375 528	1 pc.	7,3 F	55 cm	Extended Hook
Selectra Hook-45	375 529	1 pc.	7,3 F	45 cm	Hook
Selectra Hook-55	375 530	1 pc.	7,3 F	55 cm	Hook
Selectra MPEP-45	375 531	1 pc.	7,3 F	45 cm	Multipurpose EP (MPEP)
Selectra MPEP-55	375 532	1 pc.	7,3 F	55 cm	Multipurpose EP (MPEP)
Selectra Multipurpose Hook-45 (MPH)	375 533	1 pc.	7,3 F	45 cm	Multipurpose Hook (MPH)
Selectra Multipurpose Hook-55 (MPH)	375 534	1 pc.	7,3 F	55 cm	Multipurpose Hook (MPH)
Selectra Right-45	375 535	1 pc.	7,3 F	45 cm	Right
Selectra Right-55	375 536	1 pc.	7,3 F	55 cm	Right
Selectra Straight-45	375 537	1 pc.	7,3 F	45 cm	Straight
Selectra Straight-55	375 521	1 pc.	7,3 F	55 cm	Straight

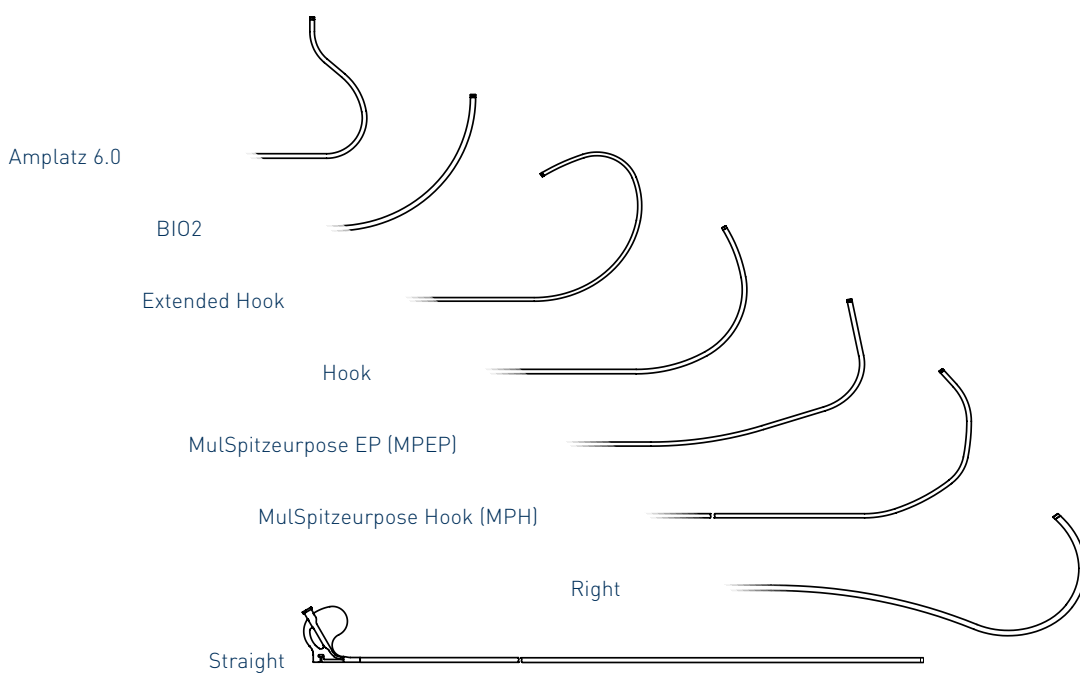

Telescopic Coronary Sinus Lead Delivery System Selectra

Peel-away introducer sheath with valve to introduce coronary sinus lead delivery system

Inner Catheters



Model	Order Number	Packaging Unit	Length	Tip
Selectra IC-50-59	392 289	1 pc.	59 cm	50° angled
Selectra IC-50-69	392 290	1 pc.	69 cm	50° angled
Selectra IC-90-59	392 291	1 pc.	59 cm	90° angled
Selectra IC-90-69	392 292	1 pc.	69 cm	90° angled

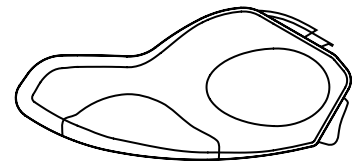

Model	Order Number	Packaging Unit	Description
Selectra Slitter	383 119	1 pc.	Slitter Tool for Telescopic Coronary Sinus Lead Delivery System Selectra (for leads with a diameter between 4.6 and 5.8 F)

3

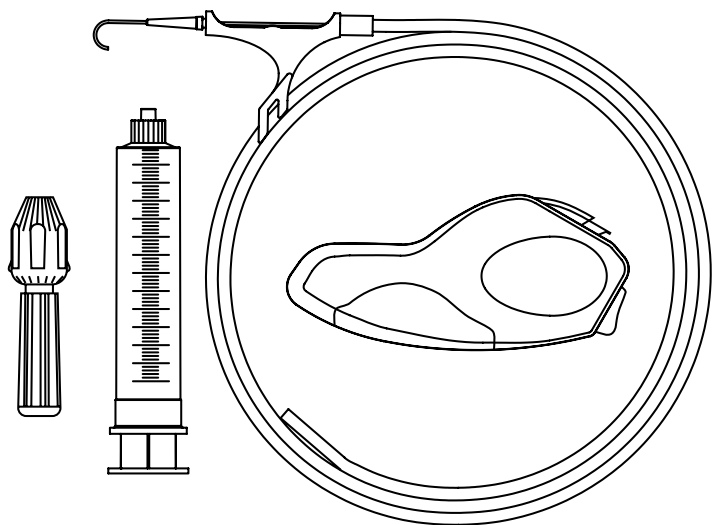

Model	Order Number	Description
Selectra Accessory Kit	375 518	Package contents: 1 slitter tool, 1 guide wire (Seldinger wire), 4 transvalvular insertion tool (TVI), 1 syringe, 1 torque tool for guide wires for OTW leads, 2 one-way valve, 2 one-way stopcocks, 2 sealing caps

3 CRT-P and CRT-D (triple-chamber)

LV Coronary Sinus Lead Delivery System CSG⁴

The peel-away LV coronary sinus lead delivery system SafeSheath CSG is a combination of guiding catheter and implantation accessories used to facilitate access to the coronary venous system for suitable leads and catheters.

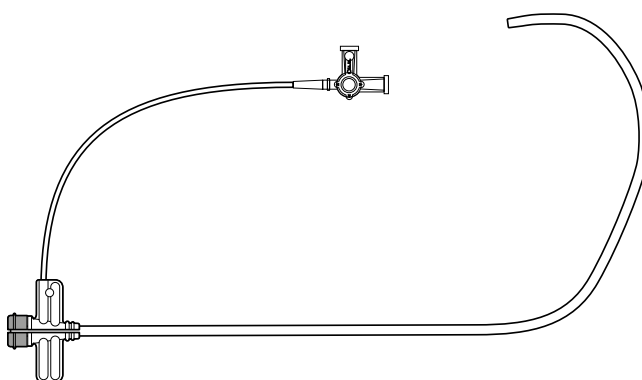

Model	Order Number	Packaging Unit	Description
CSG / Worley 1-09 Standard NG	375 230	1 pc.	CSG/Worley 1-09 Standard NG, coronary sinus lead delivery system, peel-away system, 9 F
CSG / Worley 2-09 Jumbo NG	375 229	1 pc.	CSG/Worley 2-09 Jumbo NG, coronary sinus lead delivery system, peel-away system, 9 F
CSG / Worley BCOR-1-09 Standard NG	375 228	1 pc.	CSG/Worley BCOR-1-09 Standard NG, coronary sinus lead delivery system, peel-away system, 9 F
CSG / Worley BCOR-2-09 Jumbo NG	375 227	1 pc.	CSG/Worley Braided Core 2-09 Jumbo, coronary sinus lead delivery system peel-away system, 9 F
CSG 90-09 SafeSheath 9F NG	375 231	1 pc.	CSG 90-09 SafeSheath 9F NG, coronary sinus lead delivery system, peel-away system, 9 F

Lead Introducer System with Valve SafeSheath II⁵

The peel-away lead introducer system with valve - SafeSheath II - is a combination of guiding catheter and implantation accessories used to facilitate access to the coronary venous system for suitable leads and catheters.

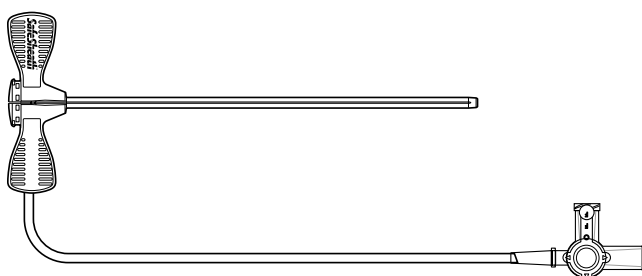

Model	Order Number	Packaging Unit	Inner Diameter	Length
SafeSheath II SS6	398 339	5 pcs.	6 F	13 cm
SafeSheath II SS7	398 340	5 pcs.	7 F	13 cm
SafeSheath II SS8	398 343	5 pcs.	8 F	13 cm
SafeSheath II SS9	398 346	5 pcs.	9 F	13 cm
SafeSheath II SS10	398 348	5 pcs.	10 F	13 cm
SafeSheath II SS11	398 350	5 pcs.	11 F	13 cm
SafeSheath II SS12	400 088	5 pcs.	12 F	13 cm
SafeSheath II SSL6	400 209	5 pcs.	6 F	23 cm
SafeSheath II SSL7	398 353	5 pcs.	7 F	23 cm
SafeSheath II SSL8	398 355	5 pcs.	8 F	23 cm
SafeSheath II SSL9	398 356	5 pcs.	9 F	23 cm
SafeSheath II SSL10	398 357	5 pcs.	10 F	23 cm

⁴ Manufacturer: Merit Medical, 1600 West Merit Parkway South Jordan, UT 84095, USA

⁵ Manufacturer: Ocor, 3816 DeSoto Blvd., Palm Harbor, FL 34683, USA

Balloon Catheter

Corodyn⁶

Peel-away introducer sheath with valve to introduce coronary sinus lead delivery system

Usable Length: 80 cm
Outer Diameter: 1.98 mm

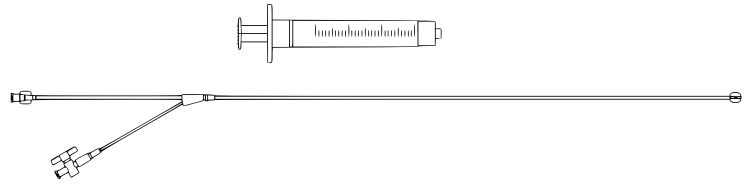

Model	Order Number	Packaging Unit	Tip Shape	Introducer Size Required	Recommended Guide Wire Size
Corodyn P1 Venogram Balloon Catheter	336 074	1 pc.	Soft J	6 F	0.63 mm

Guide Wires

Streamer⁷

Polymer guide wire for LV lead implantation

Length: 195 cm
Diameter: 0.014" (0.36 mm)

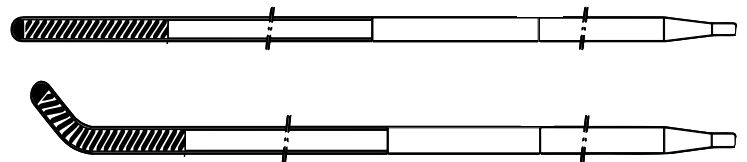

Model	Order Number	Packaging Unit	Shaft Flexibility	Tip Configuration	Tip Flexibility
Streamer ES	363 724	5 pcs.	Extra Support (ES)	straight	High flexible (HF)
Streamer ES-J	363 725	5 pcs.	Extra Support (ES)	J-shaped	High flexible (HF)
Streamer XT	363 726	5 pcs.	Extra Distal Support (XT)	straight	High flexible (HF)
Streamer XT-J	363 727	5 pcs.	Extra Distal Support (XT)	J-shaped	High flexible (HF)

VisionWire⁷

Insulated guide wire for electrical probing of the target vessel

Length: 175 cm
Diameter: 0.014" (0.36 mm)

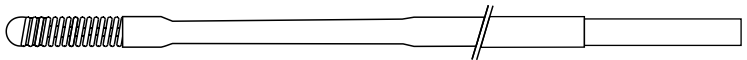

Model	Order Number	Packaging Unit	Shaft Flexibility	Tip	
				Configuration	Flexibility
VisionWire	352 023	1 pc.	Extra Support	straight	floppy

⁶ Manufacturer: B. Braun Melsungen AG, Carl-Braun-Straße 1, 34212 Melsungen, Germany

⁷ Manufacturer: BRIVANT LTD., Parkmore West Business Park, Galway, County Galway, Ireland

4 Arrhythmia Monitoring

BioMonitor 2 (Cardiac Monitor)

BioMonitor 2-AF and BioMonitor 2-S are cardiac monitors for the monitoring and automatic recording of the heart rhythm. Their primary purpose is to provide early detection and diagnostics of symptoms of arrhythmias.

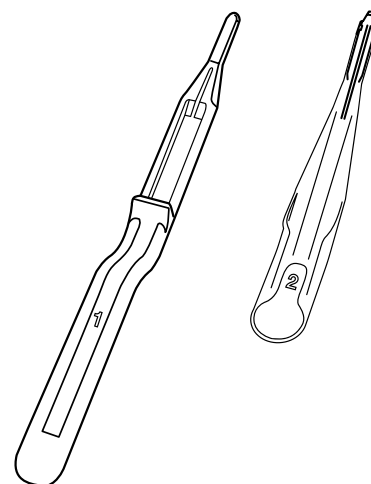

Model	Order Number	Packaging Unit	Description
FIT-Set (Fast Insert Tools FIT 1 and FIT 2)	408 906	1 pc.	For the fast and easy insertion of the BioMonitor 2-S or BioMonitor 2-AF

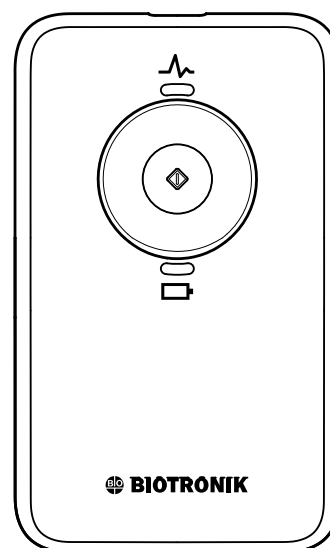

Model	Order Number	Packaging Unit	Description
Remote Assistant	405 475	1 pc.	Patient device for BioMonitor 2: Transmitter for manual triggering of recording in BioMonitor 2 by patient

5 BIOTRONIK Home Monitoring®

BIOTRONIK Home Monitoring® is a pioneering and award-winning remote cardiac monitoring system for patients with diagnostic and therapeutic cardiac implantable devices. Daily and automatic Home Monitoring implants wirelessly communicate with a mobile patient monitoring device, the CardioMessenger. Once the CardioMessenger received the data from the device, it forwards them to the BIOTRONIK Home Monitoring Service Center for patient-individual evaluation.

The BIOTRONIK Home Monitoring technology enables safe in-office follow-up replacements by doing remote follow-ups according to patient needs and early detection of clinical or technical relevant events.⁸ Several studies demonstrate that BIOTRONIK Home Monitoring significantly improves clinical outcomes and survival compared to only periodic, in-person device follow-ups.⁹⁻¹¹



Model	Order Number	Packaging Unit	Description
CardioMessenger Smart 2G CE	401 826	1 pc.	Transmitter for the BIOTRONIK Home Monitoring® system
CardioMessenger Smart 3G CE	419 318	1 pc.	Transmitter for the BIOTRONIK Home Monitoring® system
Power Supply Brick FW7520/05 100-240VAC-5VDC	399 493	1 pc.	Power Supply Brick for the CardioMessenger Smart

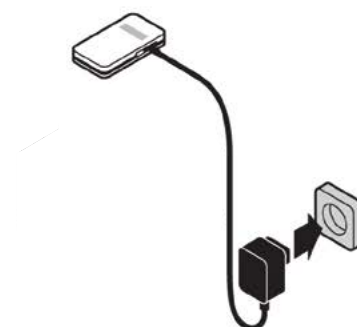
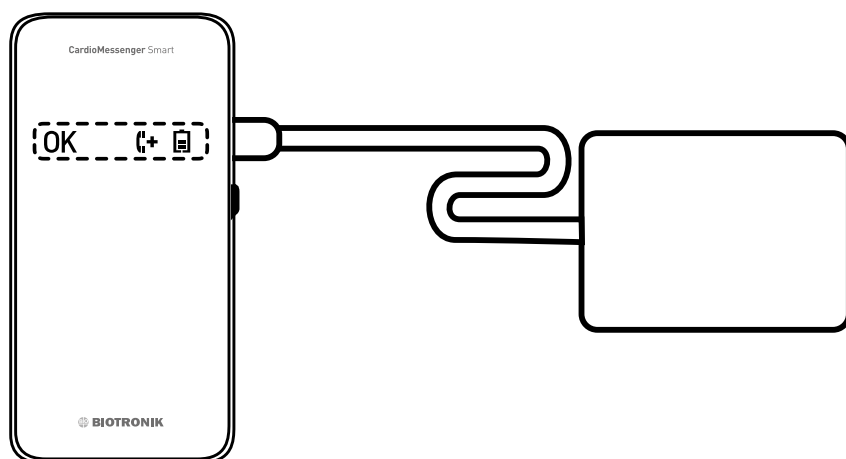

⁸ Varma N et al.; The TRUST trial, *Circulation* 2010; 122:325; doi: 10.1161/CIRCULATIONAHA.110.937409.

⁹ Hindricks G et al.; IN-TIME study. *The Lancet* 2014; 384(9943).

¹⁰ Guedón-Moreau et al.; ECOST study. *European Heart Journal* 2012. Doi: 10.1161/CIRCEP.110.951962.

¹¹ Mabo P et al.; The COMPAS trial. *European Heart Journal* 2011, doi: 10.1093/eurheartj/ehr419.

6 External Devices

Programmer and Monitoring Device

Renamic

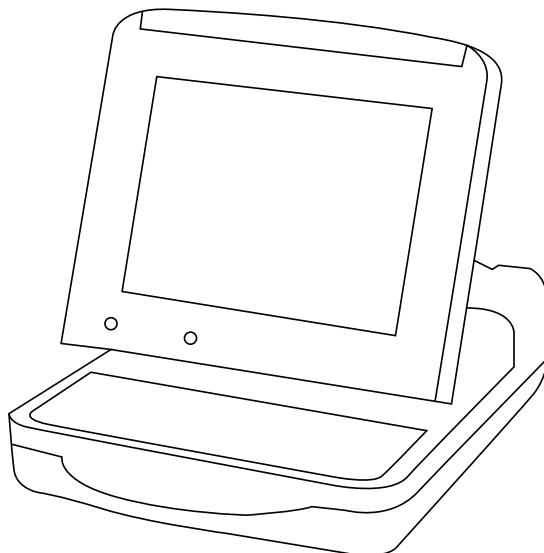

Model	Order Number	Packaging Unit	Description
Renamic	371 960	1 pc.	Portable programmer and monitoring device. used during the implantation procedure and follow-up of BIOTRONIK pacemakers, ICDs or cardiac monitors. Available with or without UMTS modul (customer-specific)*

Expansion Modul for Renamic

PSA Modul

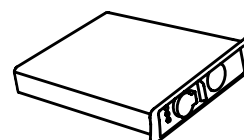

Model	Order Number	Packaging Unit	Description
Renamic PSA Module	386 610	1 pc.	Expansion module which is used during the implantation procedure of pacemakers or ICDs.

*Not available in all countries

Patient Cables

Cable Connections for external devices of BIOTRONIK.



Model	Order Number	Packaging Unit	Length	Resterilization	Description
PK-67-S	128 085	1 pc.	0.8 m	Yes ^{Procedure 1}	Used in combination with the patient adapters PA-1-B, PA-1-C, PA-2, PK-155 and connection to the Redel adapter (Reecor).
PK-67-L	123 672	1 pc.	2.6 m	Yes ^{Procedure 1}	



Model	Order Number	Packaging Unit	Length	Resterilization	Description
PK-82	128 564	1 pc.	1.5 m	Yes ^{Procedure 1}	Extension cable with alligator clips for connection to Reecor

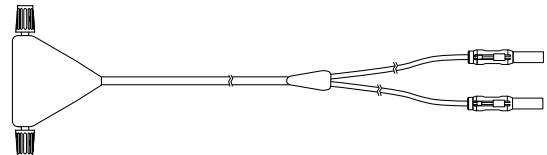

Model	Order Number	Packaging Unit	Length	Resterilization	Description
PK-83	128 562	1 pc.	1.5 m	Yes ^{Procedure 1, 2}	Extension cable with screw terminals for combination with temporary leads (TC) and direct connection to Reecor S or 2x PK-83 to Reecor D.
PK-83	128 563	1 pc.	2.5 m	Yes ^{Procedure 1, 2}	

Model	Order Number	Packaging Unit	Description
TC Adapter Kit ¹³	380 390	5 pcs.	2 mm adapter system for temporary pacemakers and EP-Measurement-Systems, unsterile

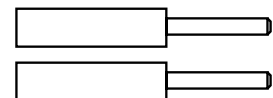

Procedure 1: 121 °C high pressure steam, 1.1 bar, for a maximum of 20 min.

Procedure 2: 134 °C high pressure steam, 2.2 bar, for a maximum of 5 min.

Procedure 3: 134 °C high pressure steam, 3.0 bar, for a maximum of 18 min.

¹³ Manufacturer: VascoMed GmbH, Hertzallee 1, 79589 Binzen, Germany

6 External Devices

Patient Cables

Cable Connections for external devices of BIOTRONIK.



Model	Order Number	Packaging Unit	Length	Resterilization	Description
PK-83-B	347 606	1 pc.	1.5 m	Yes <small>Procedure 1, 2, 3</small>	Extension cable with screw terminals for combination with temporary leads (TC) and connection to Reocor S via Redel adapter.
PK-83-B	347 485	1 pc.	2.5 m	Yes <small>Procedure 1, 2, 3</small>	

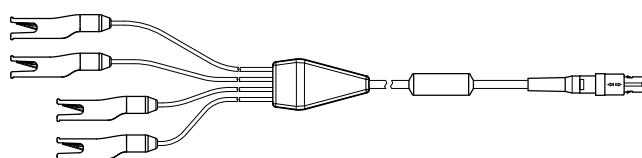

Model	Order Number	Packaging Unit	Length	Resterilization	Description
PK-141	353 181	1 pc.	2.8 m	Yes <small>Procedure 1, 2</small>	With clips for operative measurement (Reliaty/Renamic PSA) and external pacing (direct connection, preferred with Reocor D or only ventricular channel of Reocor S)

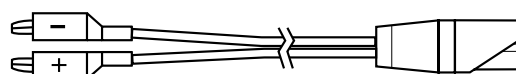

Model	Order Number	Packaging Unit	Length	Resterilization	Description
PK-155-B ¹²	404 027	2 pcs.	2.0 m	No	Used in connection between the implantable lead and the patient cable PK-67-S or PK-67-L. With clips for intracardial measurement (Reliaty/Renamic PSA) and external pacing (Reocor S).

¹² Manufacturer: Remington Medical Inc., 6830 Meadowridge Court, Alpharetta, GA 30005, USA

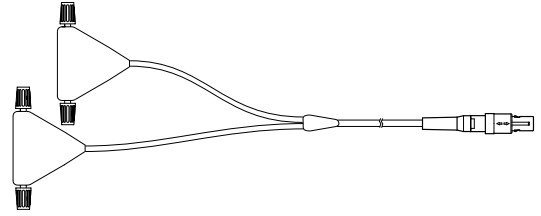

Model	Order Number	Packaging Unit	Length	Resterilization	Description
PK-175	333 959	1 pc.	2.3 m	Yes ^{Procedure 2, 3}	With screw terminals, for bifocal pacing [Reocor]

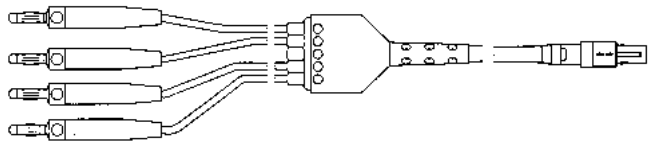

Model	Order Number	Packaging Unit	Length	Resterilization	Description
PK-222 EU	335 284	1 pc.	2.8 m	No	3 channel patient cable for surface ECG

Model	Order Number	Packaging Unit	Description
PK Lead Clip	340 293	1 pc.	PK Lead Clip for patient cable PK-222

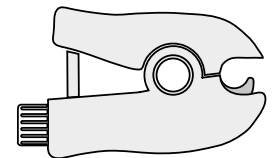

Procedure 1: 121 °C high pressure steam, 1.1 bar, for a maximum of 20 min.

Procedure 2: 134 °C high pressure steam, 2.2 bar, for a maximum of 5 min.

Procedure 3: 134 °C high pressure steam, 3.0 bar, for a maximum of 18 min.

6 External Devices

Patient Adapter

Cable Connections for external devices of BIOTRONIK.

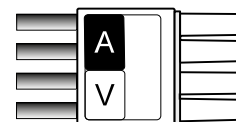

Model	Order Number	Packaging Unit	Resterilization	Description
PA-1-B	123 751	1 pc.	Yes ^{Procedure 1}	Used in combination with 2 x 2-mm-plugs and connection to the patient cable PK-67-S/-L.

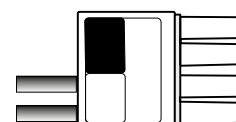

Model	Order Number	Packaging Unit	Resterilization	Description
PA-1-C	349 723	1 pc.	Yes ^{Procedure 1}	Used in combination with 2 x 2-mm-plugs and connection to the patient cable PK-67-S/-L. For single-chamber device systems

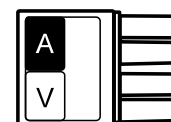

Model	Order Number	Packaging Unit	Resterilization	Description
PA-2	123 157	1 pc.	Yes ^{Procedure 1}	Used in combination with 2 IS-1 leads and connection to the patient cable PK-67-S/-L.

Procedure 1: 121 °C high pressure steam, 1.1 bar, for a maximum of 20 min.

Procedure 2: 134 °C high pressure steam, 2.2 bar, for a maximum of 5 min.

Procedure 3: 134 °C high pressure steam, 3.0 bar, for a maximum of 18 min.

Further Accessories

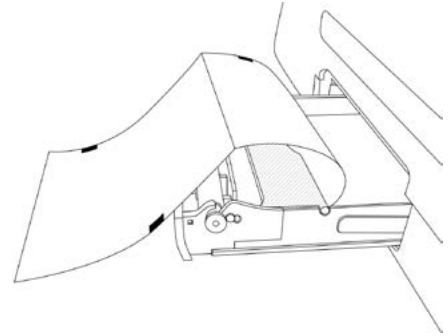

Model	Order Number	Packaging Unit	Description
Printer Paper for Programmer Devices	435 347	20 pcs.	For Renamic and ICS 3000

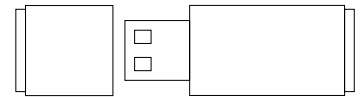

Model	Order Number	Packaging Unit	Description
Memory Stick (compatible with Renamic and ICS 3000)	350 017	1 pc.	For connection to the USB interface of the programmer; e. g. for data export or software updates



Model	Order Number	Packaging Unit	Description
Programming Head (PGH) Plastic Cover ¹⁴	396 985	10 pcs.	Sterile protective cover for PGH, single-use, cannot be reesterilized, For Renamic and ICS 3000

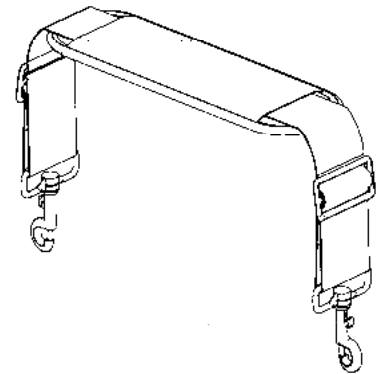

Model	Order Number	Packaging Unit	Description
Shoulder Strap Renamic	371 962	1 pc.	Carrying strap that can be fixed to the Renamic hangers

¹⁴Manufacturer: Palmedic b.v., Koningslinde 12, 7131MP Lichtenvoorde, Netherlands

6 External Devices

Further Accessories

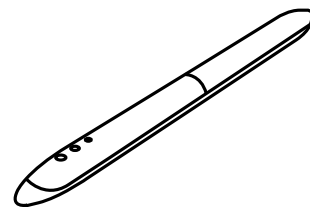

Model	Order Number	Packaging Unit	Description
Stylus Renamic	371 586	1 pc.	To use with the Renamic touchscreen

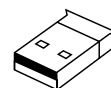

Model	Order Number	Packaging Unit	Description
USB Bluetooth Adapter*	367 929	1 pc.	Bluetooth-compatible USB stick for wireless connection with other devices

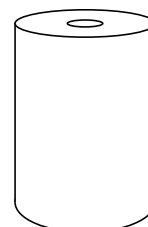

Model	Order Number	Packaging Unit	Description
ERA-P	111 743	2 pcs.	Paper Rolls for printer of the ERA 3000/300

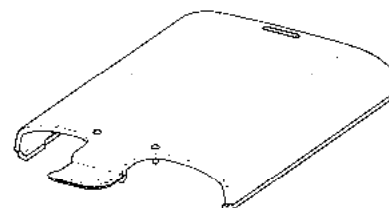

Model	Order Number	Packaging Unit	Description
Protective Cover Reocor	378 007	1 pc.	A movable, transparent cover of the controls to prevent accidental changes of the programmed parameters. For Reocor S and D

* Not available in all countries

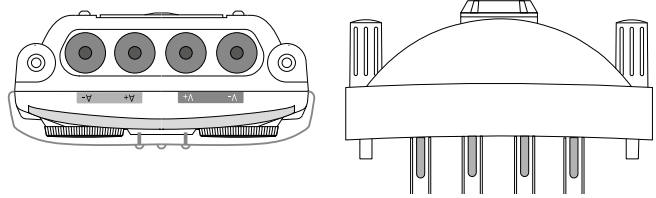

Model	Order Number	Packaging Unit	Description
Redel-Adapter for Reocor D	371 262	1 pc.	Adpater for indirect connection of different patient cables

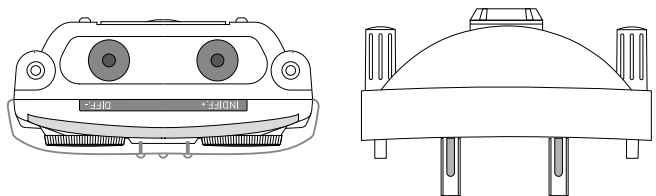

Model	Order Number	Packaging Unit	Description
Redel-Adapter for Reocor S	371 263	1 pc.	Adpater for indirect connection of different patient cables

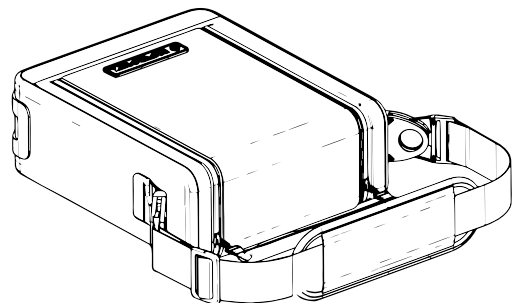

Model	Order Number	Packaging Unit	Description
Softcase Reocor	369 603	1 pc.	For Reocor D and S

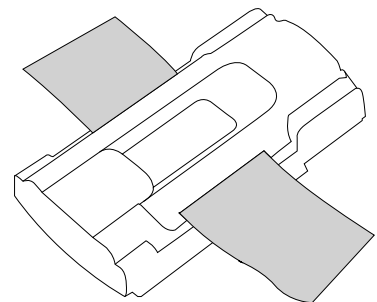

Model	Order Number	Packaging Unit	Description
Armband	103 704	1 pc.	For fixation of the external pacemaker on the patient's arm For Reocor and EDP

ACCESSORIES

Cardiac Rhythm Management

Visit us at biotronik.com

and follow us on Twitter, LinkedIn and Youtube.



@BIOTRONIK_News



[linkedin.com/company/biotronik](https://www.linkedin.com/company/biotronik)



[youtube.com/user/BIOTRONIKmedia](https://www.youtube.com/user/BIOTRONIKmedia)

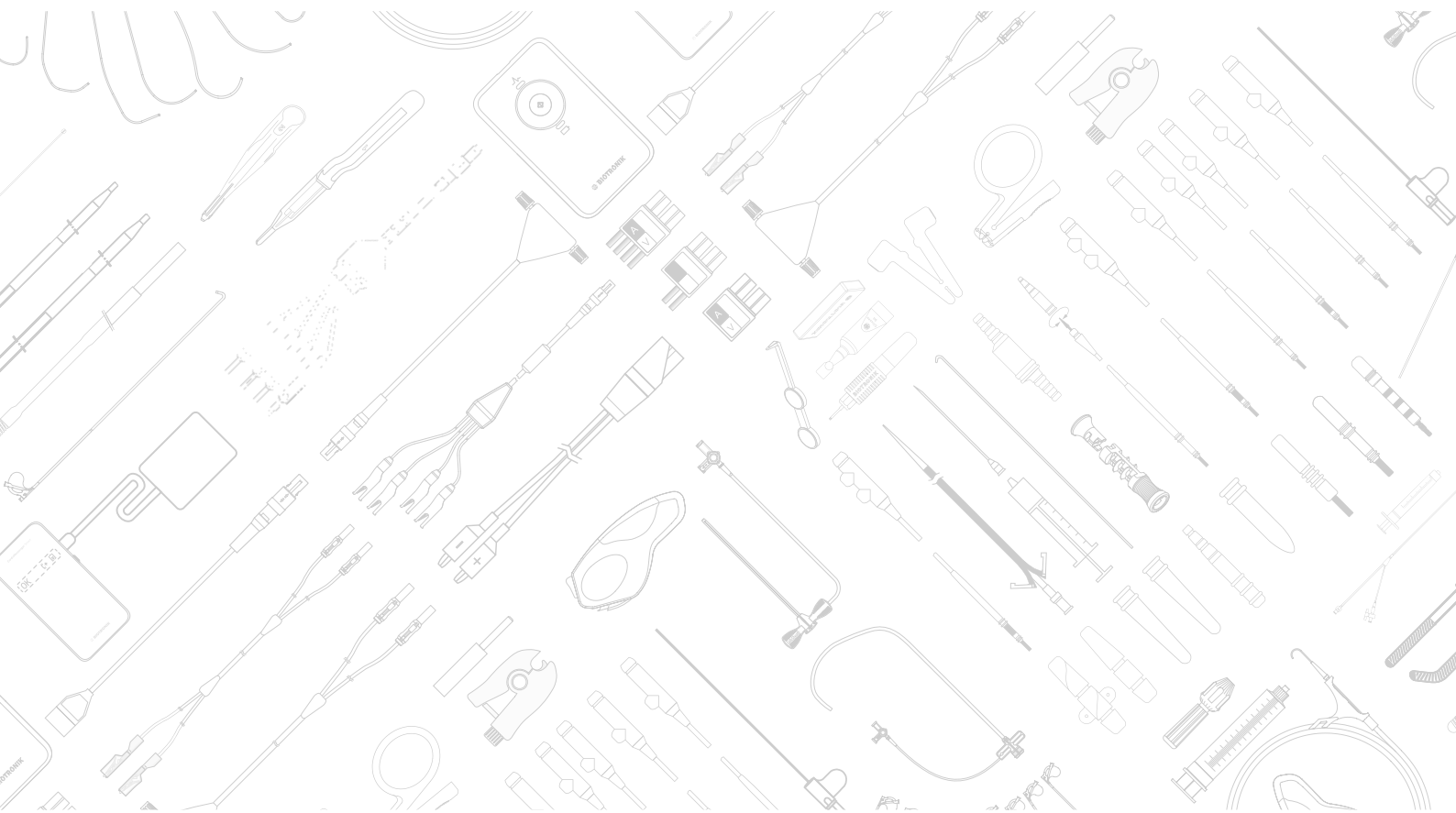

BIOTRONIK

excellence for life

BIOTRONIK Vertriebs GmbH & Co. KG
Woermannkehre 1
12359 Berlin - Germany

Tel +49 (0)30 68905-0
Fax +49 (0)30 6852804

sales@biotronik.com
www.biotronik.com

CE 0123
0681

© BIOTRONIK SE & Co. KG
All rights reserved.
Specifications are subject to
modification, revision and improvement.